

C161

Height: 4'-9"

Depth: 0'-1³/₁₆"

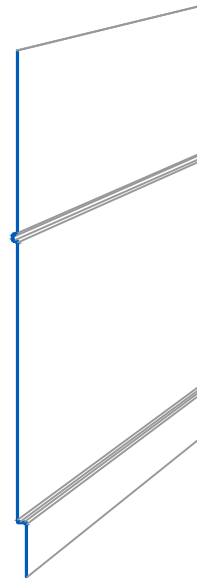

C162

Height: 0'-4"

Depth: 2'-10¹⁵/₁₆"



C163

Height: 1'-10¹/₂"

Depth: 2'-0³/₁₆"

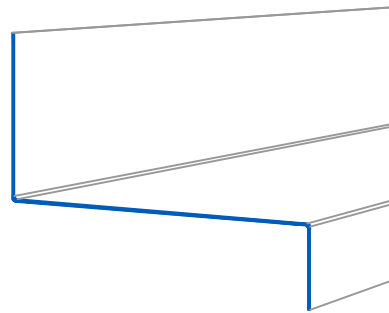

C164

Height: 0'-6"

Depth:

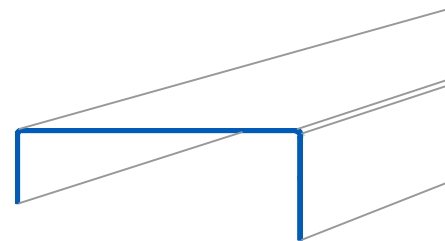

We have detailed CAD drawings available, Please inquire.

Fiblast, LLC

1602 Mizell Road, Tuskegee, AL 36083

Phone: (334) 513-1314 E-mail: PM1@fiblast.com

C165

Height: 2'-10⁵/₁₆"

Depth: 1'-11⁵/₁₆"

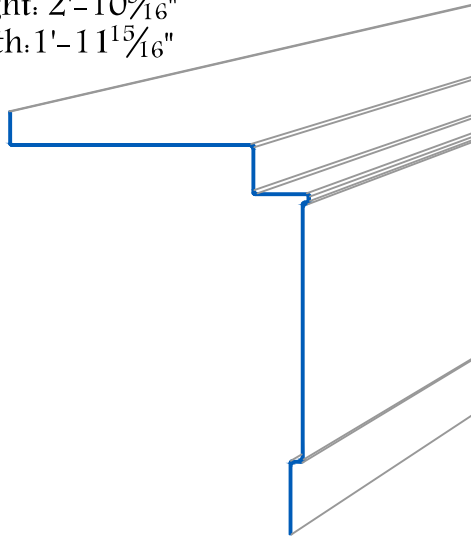

C166

Height: 2'-1³/₁₆"

Depth: 0'-4¹/₄"

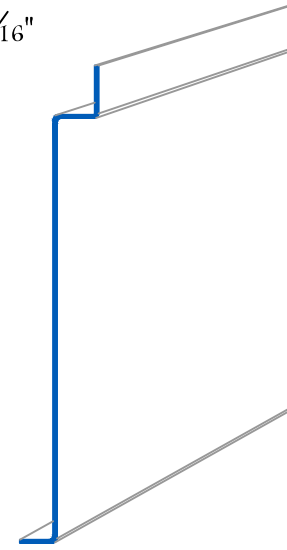

C167

Height: 1'-6¹⁵/₁₆"

Depth: 1'-0"

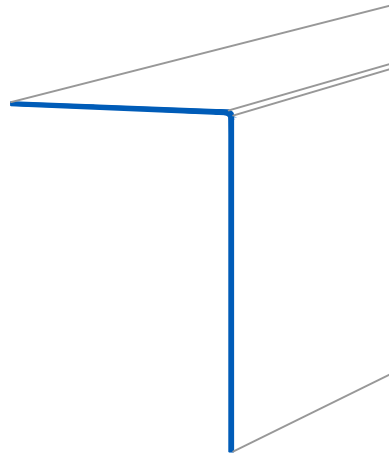

C168

Height: 2'-1³/₁₆"

Depth: 0'-3⁷/₁₆"

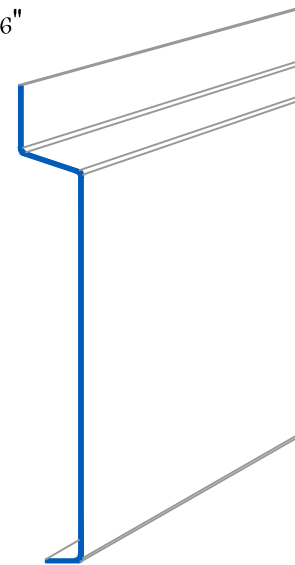

We have detailed CAD drawings available, Please inquire.

Fiblast, LLC

1602 Mizell Road, Tuskegee, AL 36083

Phone: (334) 513-1314 E-mail: PM1@fiblast.com

C169

Height: 1'-7"

Depth: 1'-5 $\frac{1}{8}$ "

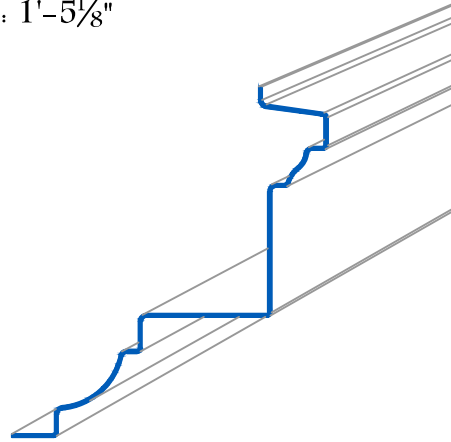

C170

Height: 0'-3"

Depth: 0'-4 $\frac{3}{4}$ "

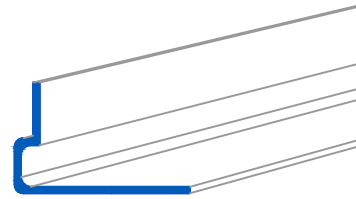

C171

Height: 1'-8 $\frac{3}{4}$ "

Depth: 1'-0"

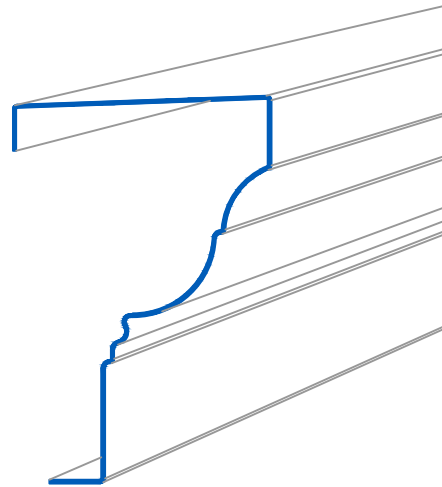

C172

Height: 1'-3 $\frac{1}{2}$ "

Depth: 0'-11"

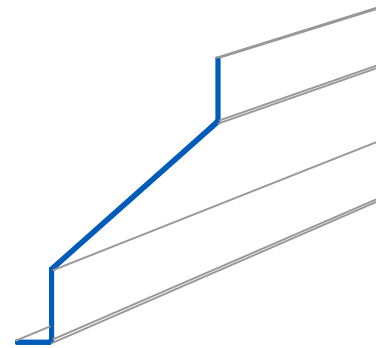

We have detailed CAD drawings available, Please inquire.

Fiblast, LLC

1602 Mizell Road, Tuskegee, AL 36083
Phone: (334) 513-1314 E-mail: PM1@fiblast.com

C173
Height: 2'-4"
Depth: 1'-6"

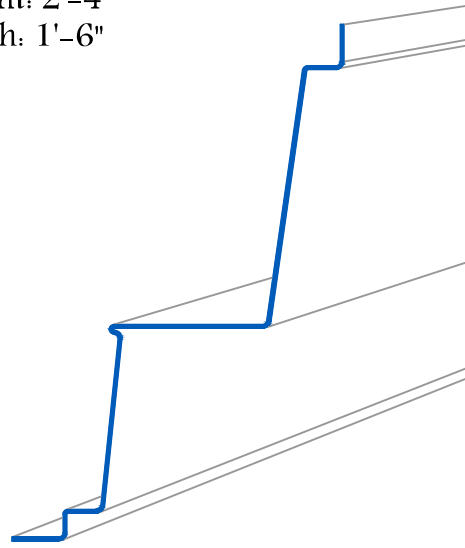

C174
Height: 0'-4¹/₁₆"
Depth:

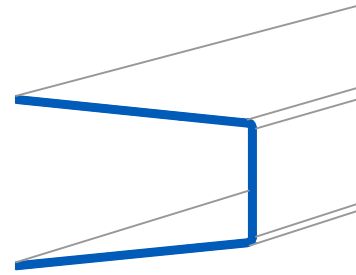

C175
Height: 6'-11"
Depth: 1'-8¹/₁₆"



C176
Height: 0'-4"
Depth: 0'-3"

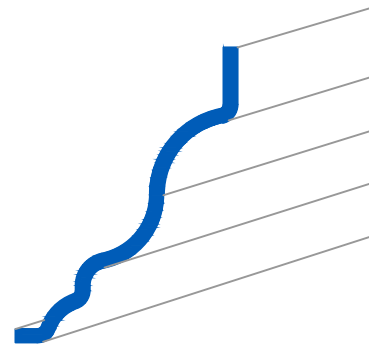

We have detailed CAD drawings available, Please inquire.

Fiblast, LLC

1602 Mizell Road, Tuskegee, AL 36083
Phone: (334) 513-1314 E-mail: PM1@fiblast.com

C177

Height: 1'4½"

Depth: 1'-3"

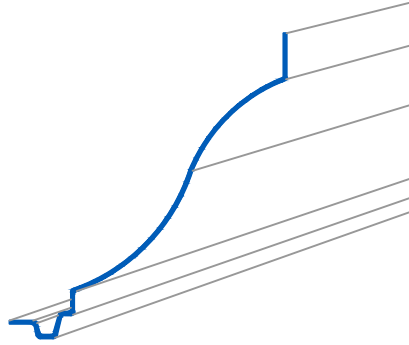

C178

Height: 0'-4½"

Depth: 0'-4"

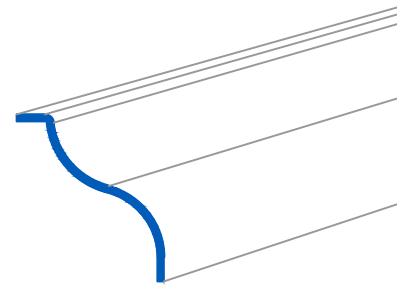

C179

Height: 3'-5⁵/₁₆"

Depth: 0'-1½"

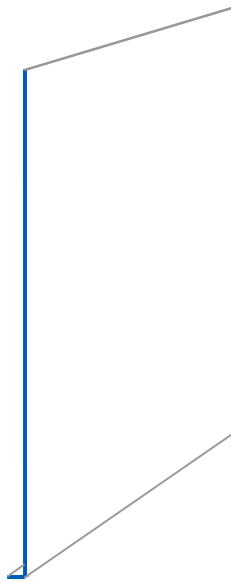

C180

Height: 0'-5½"

Depth:

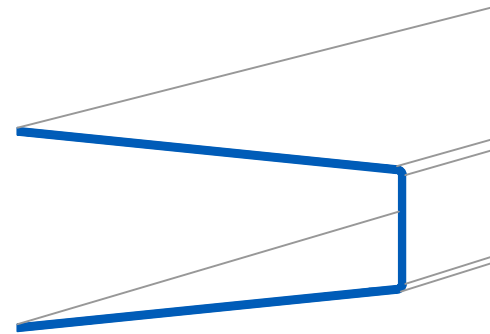

We have detailed CAD drawings available, Please inquire.

Fiblast, LLC

1602 Mizell Road, Tuskegee, AL 36083

Phone: (334) 513-1314 E-mail: PM1@fiblast.com