

C181

Height: 3'-2<sup>7</sup>/<sub>16</sub>"

Depth: 3'-2<sup>5</sup>/<sub>8</sub>"

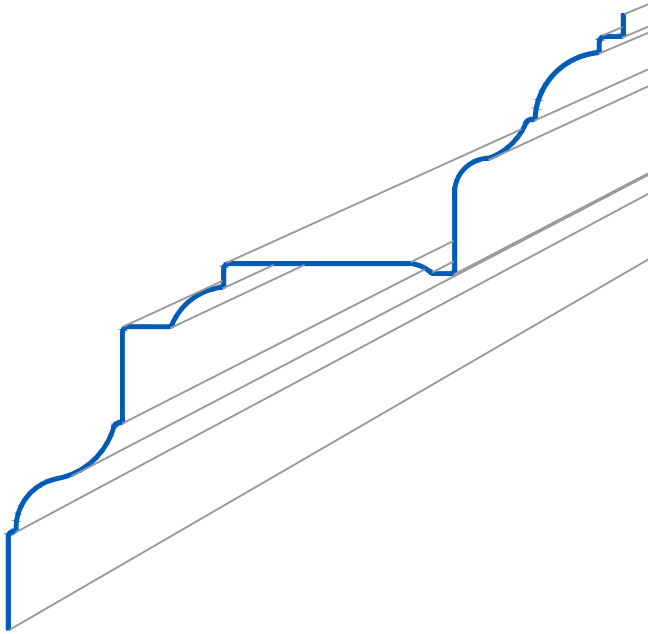

C182

Height: 0'-5"

Depth: 0'-3<sup>3</sup>/<sub>4</sub>"

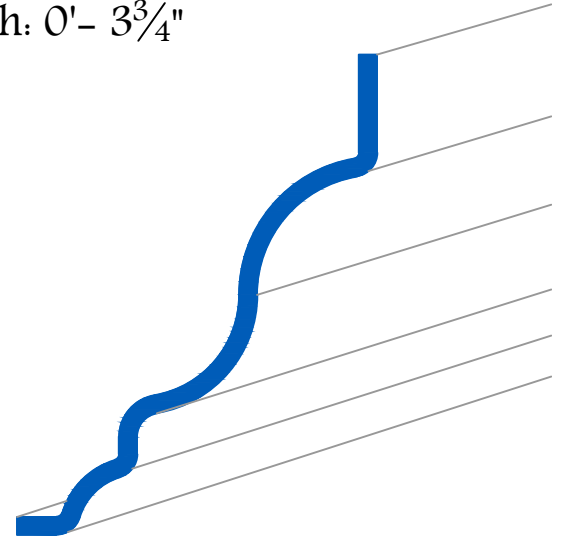

C183

Height: 1'-2"

Depth: 0'-6<sup>3</sup>/<sub>4</sub>"

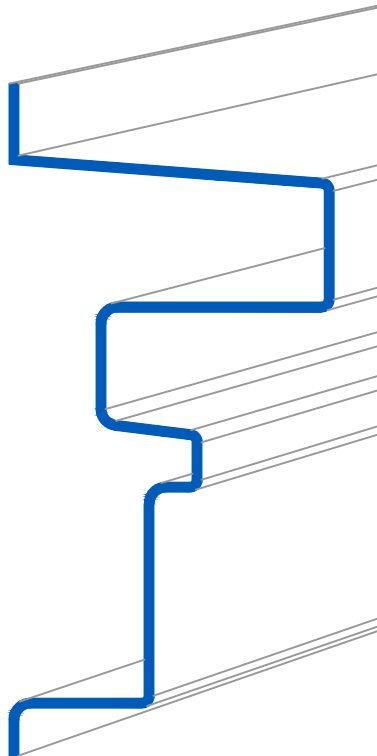

C184

Height: 1'-3<sup>7</sup>/<sub>8</sub>"

Depth: 0'-9<sup>1</sup>/<sub>8</sub>"

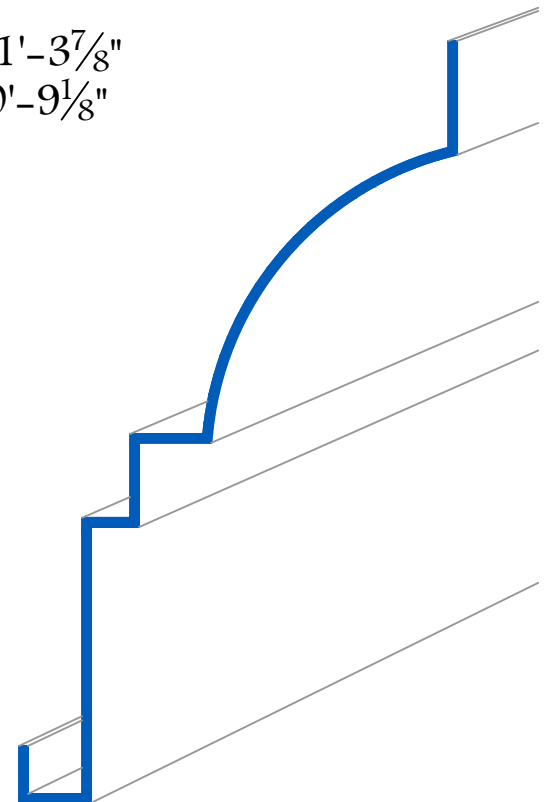

We have detailed CAD drawings available, Please inquire.

**Fiblast, LLC**

1602 Mizell Road, Tuskegee, AL 36083

Phone: (334) 513-1314 E-mail: [PM1@fiblast.com](mailto:PM1@fiblast.com)

C185

Height: 2'-9"

Depth: 3'-0"

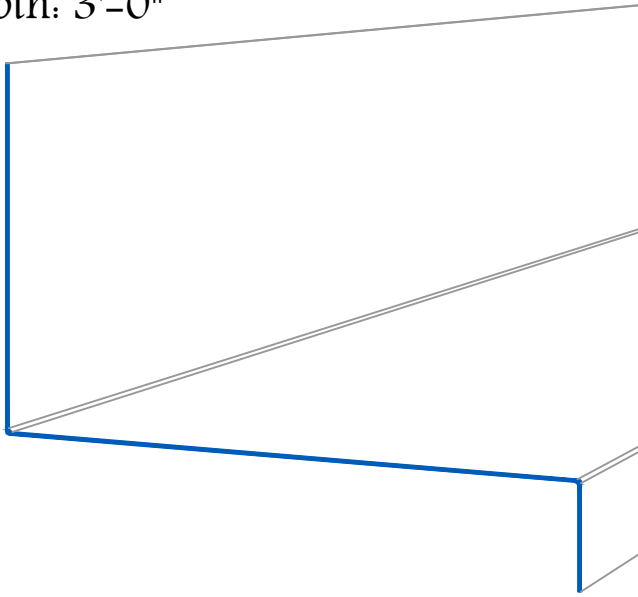

C186

Height: 1'-7"

Depth: 1'-2"

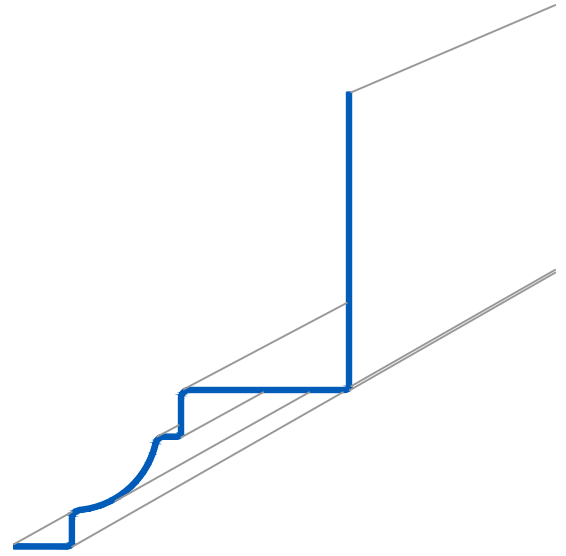

C187

Height: 2'-3"

Depth: 0'-5<sup>3</sup>/<sub>4</sub>"

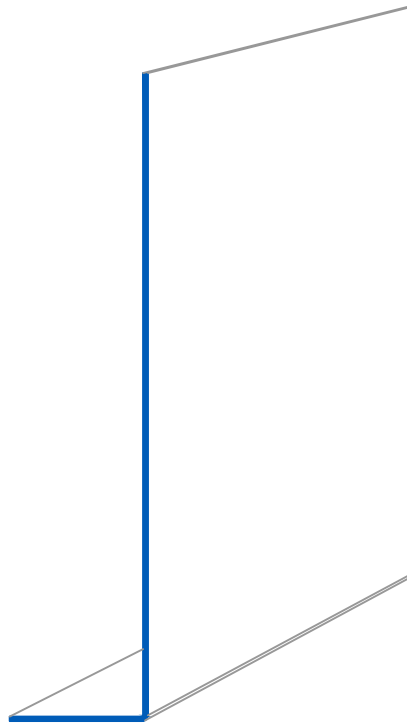

C188

Height: 2'-2<sup>1</sup>/<sub>2</sub>"

Depth: 1'-0<sup>9</sup>/<sub>16</sub>"

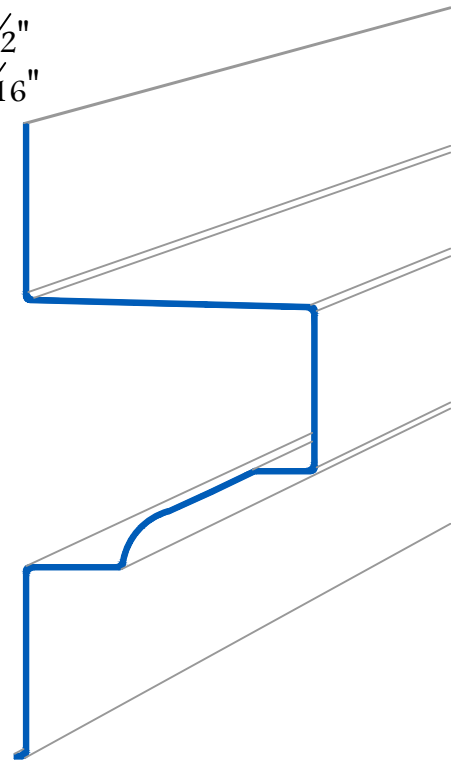

We have detailed CAD drawings available, Please inquire.

**Fiblast, LLC**

1602 Mizell Road, Tuskegee, AL 36083

Phone: (334) 513-1314 E-mail: [PM1@fiblast.com](mailto:PM1@fiblast.com)

### C189

Height: 6'-1 $\frac{1}{8}$ "

Depth: 0'-5 $\frac{3}{16}$ "

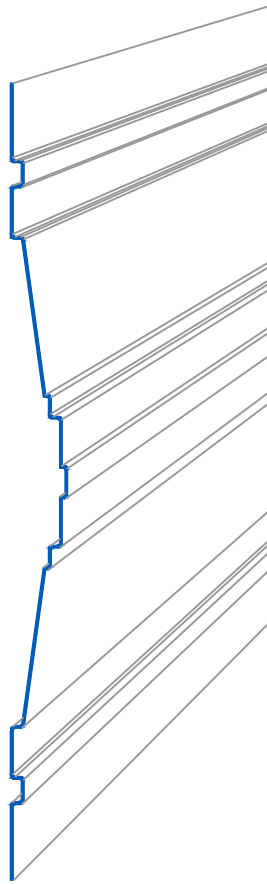

### C190

Height: 4'-3 $\frac{5}{8}$ "

Depth: 2'-0 $\frac{7}{8}$ "

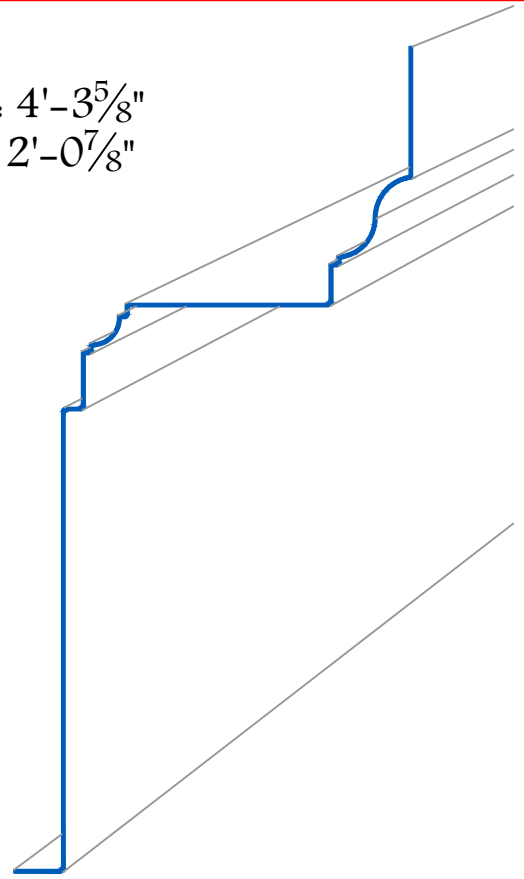

### C191

Height: 1'-4 $\frac{1}{4}$ "

Depth: 2'-5  $\frac{11}{16}$ "

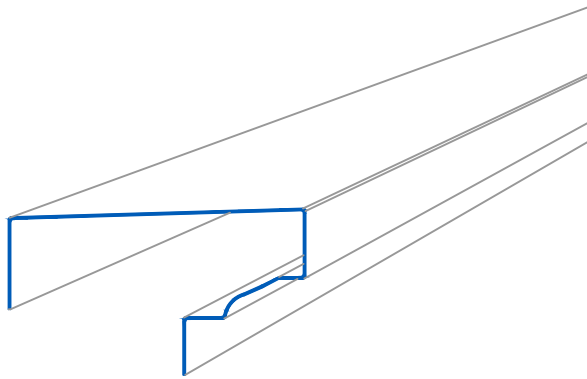

### C192

Height: 3'-7 $\frac{1}{16}$ "

Depth: 3'-4  $\frac{5}{16}$ "

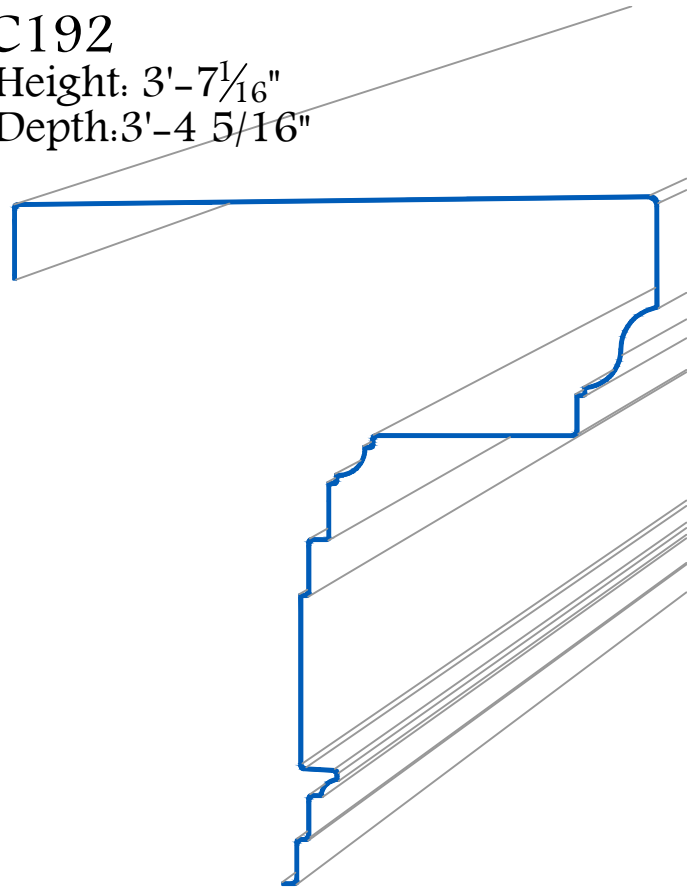

We have detailed CAD drawings available, Please inquire.

## Fiblast, LLC

1602 Mizell Road, Tuskegee, AL 36083

Phone: (334) 513-1314 E-mail: [PM1@fiblast.com](mailto:PM1@fiblast.com)

C193

Height: 3'-5<sup>7</sup>/<sub>8</sub>"

Depth: 2'-6"

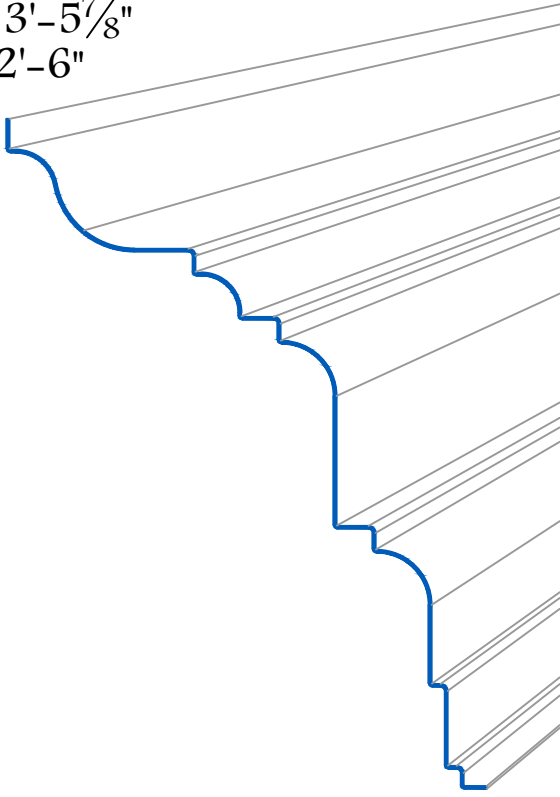

C194

Height: 0'-9<sup>1</sup>/<sub>16</sub>"

Depth: 1'-1<sup>7</sup>/<sub>16</sub>"

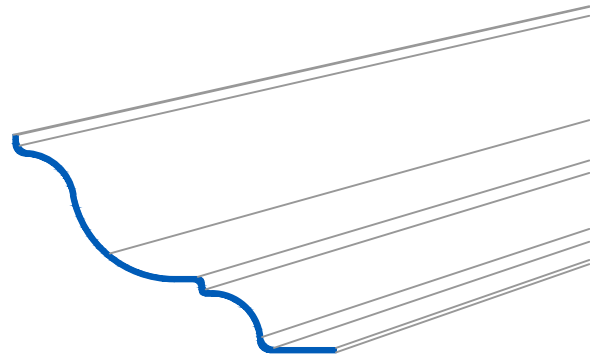

C195

Height: 3'-2<sup>1</sup>/<sub>16</sub>"

Depth: 1'-4<sup>1</sup>/<sub>16</sub>"

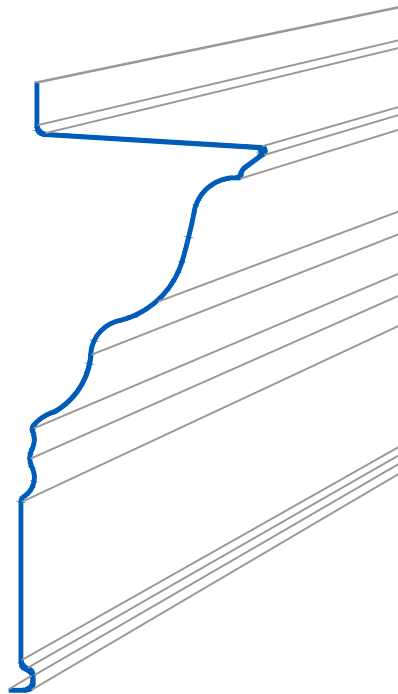

C196

Height: 0'-7<sup>1</sup>/<sub>2</sub>"

Depth: 0'-8<sup>3</sup>/<sub>8</sub>"

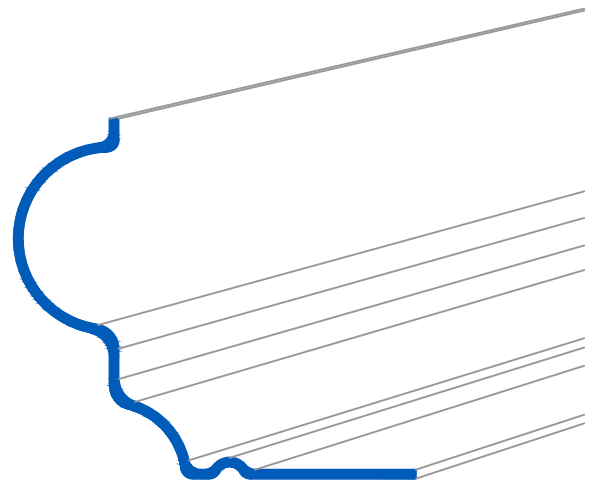

We have detailed CAD drawings available, Please inquire.

**Fiblast, LLC**

1602 Mizell Road, Tuskegee, AL 36083

Phone: (334) 513-1314 E-mail: [PM1@fiblast.com](mailto:PM1@fiblast.com)

### C197

Height: 2'-9<sup>9</sup>/<sub>16</sub>"

Depth: 2'-2<sup>3</sup>/<sub>8</sub>"

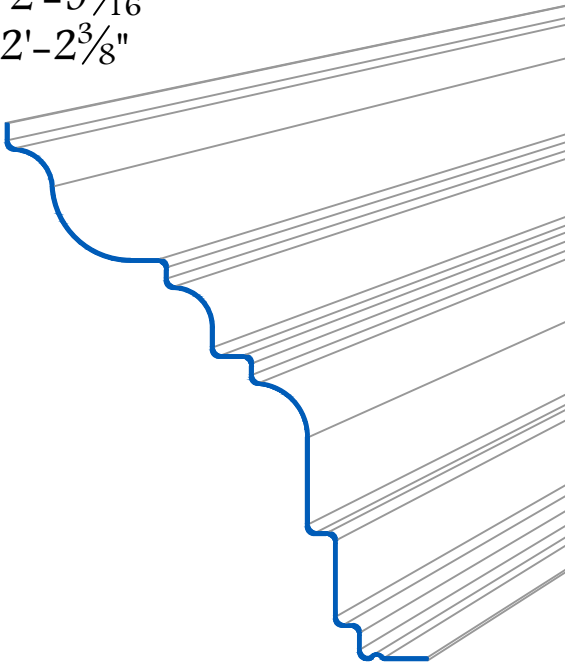

### C198

Height: 3'-2"

Depth: 0'-8<sup>5</sup>/<sub>8</sub>"

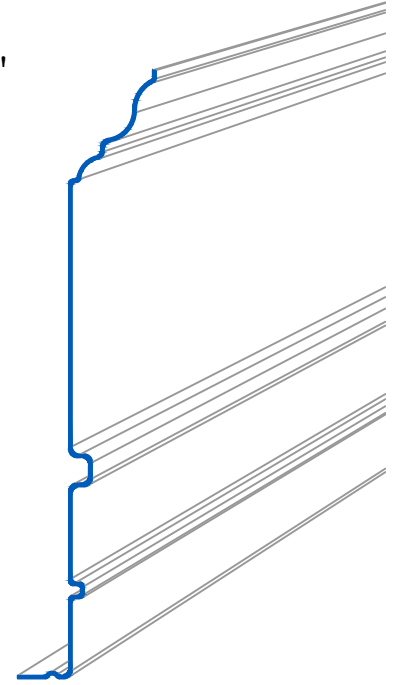

### C199

Height: 2'-7<sup>3</sup>/<sub>8</sub>"

Depth: 2'-2<sup>9</sup>/<sub>16</sub>"

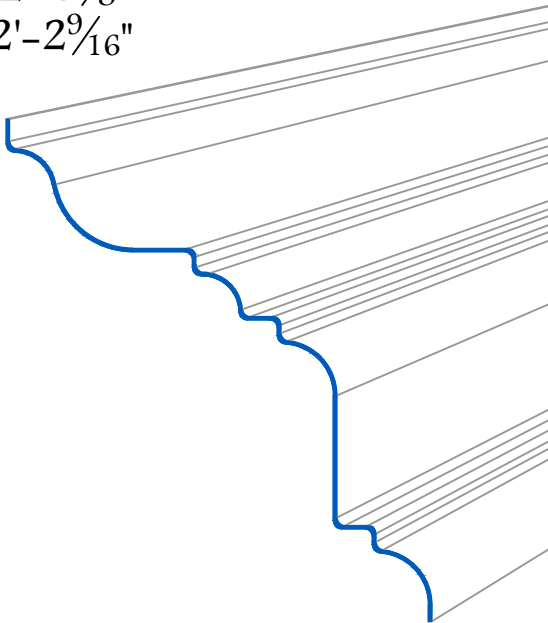

### C200

Height: 2'-6"

Depth: 4'-0<sup>5</sup>/<sub>16</sub>"

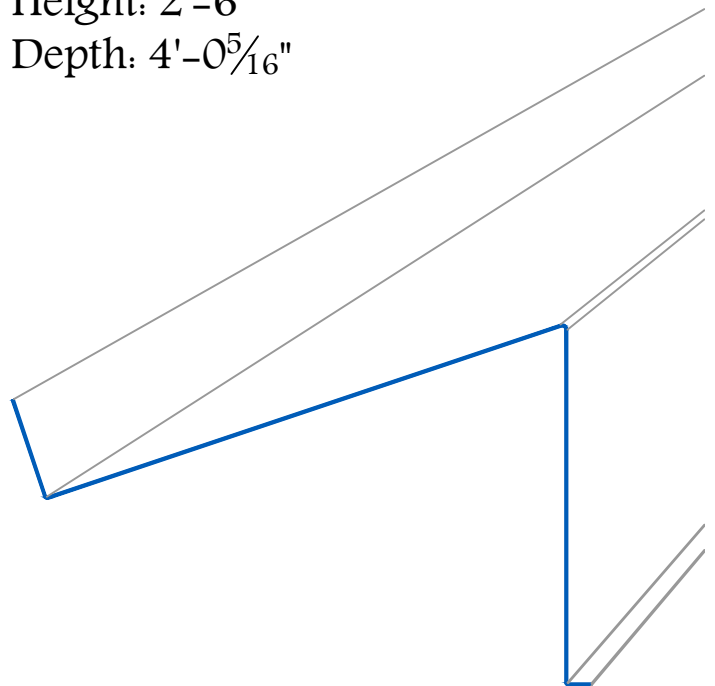

We have detailed CAD drawings available, Please inquire.

## Fiblast, LLC

1602 Mizell Road, Tuskegee, AL 36083

Phone: (334) 513-1314 E-mail: [PM1@fiblast.com](mailto:PM1@fiblast.com)